

BiClick
FLOOR

AFIRMAX

KRÁSNÁ
JAKO DŘEVO
PRAKTICKÁ
JAKO DLAŽDIČKY

PEVNÁ PODLAHA S MINERÁLNÍM JÁDREM

www.afirmax.com





PERFEKTNÍ PODLAHA DO OTEVŘENÝCH PROSTOR

Díky svým vlastnostem je naše podlaha určená do otevřených interiérů. Kuchyně společně s obývacím pokojem je srdcem každého domu. S naší podlahou s HD minerálním jádrem zůstane vaše podlaha pevná a krásná mnoho let.



Do 200 m²
Bez dilatace



HD MINERAL CORE®



Tvrdot a odolnosti
přírodních materiálů

+



Pružnost moderních
polymerů na bázi
uhlíkových molekul

V našich laboratořích jsme objevili inovativní kombinaci přírodních minerálů a pokročilých polymerů. Pečlivě zvolený poměr zajišťuje maximální výkon podlahy. Naše HD minerální jádro poskytuje extrémní odolnost, která je podložena dvacetiletou zárukou. Jsme hrdí na kvalitu našich výrobků bez ftalátů a škodlivých plastů.

Dvojitá UV
ochrana

Voděodolná
vrstva

Designová
vrstva

HD minerální
jádro

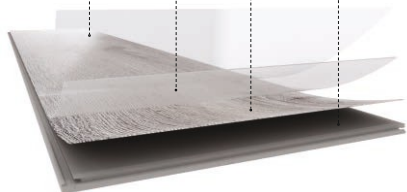

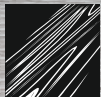

Struktura dřeva



KRÁSNÁ JAKO DŘEVO



Jemná na dotek



Tichá podlaha



Odolná
+ Silný systém
zámků



Voděodolná

PRAKTICKÁ
JAKO
KERAMICKÉ
DLAŽDICE



Podlahové
vytápění



Prostorová
stabilita

SNADNÁ INSTALACE

DÍKY ZÁMKŮM VALLINGE

V našich laboratořích jsme objevili inovativní kombinaci přírodních minerálů a pokročilých polymerů. Pečlivě zvolený poměr zajišťuje maximální výkon podlahy. Naše HD minerální jádro poskytuje extrémní odolnost, která je podložena dvacetiletou zárukou. Jsme hrdí na kvalitu našich výrobků bez ftalátů a škodlivých plastů.

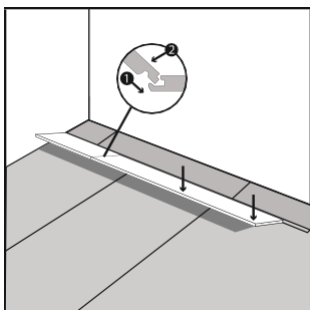
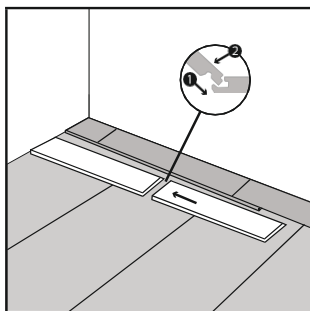

**NEMŮŽE TO BÝT
SNAŽŠÍ**





IDEÁLNÍ PRO
PODLAHOVÉ
VYTÁPĚNÍ



100%
VODĚODOLNÁ



TICHÁ
CHŮZE



PEVNÝ
ZÁMEK



EXTRA
PROSTOROVÁ
STABILITA



JEDEN
PROSTOR
JEDNA
PODLAHA

180 mm



1220 mm



2,196 m²



105,408 m²

0.3 mm

4,0 mm



DUB BRADFORD



BiClick
LAMELLE

DUB BRADFORD CBC 41122
EAN 5905167814222

DUB JERSEY



BiClick
LAMELLE

DUB JERSEY CBC 41102
EAN 5905167814284

DUB SCANDINAVIAN

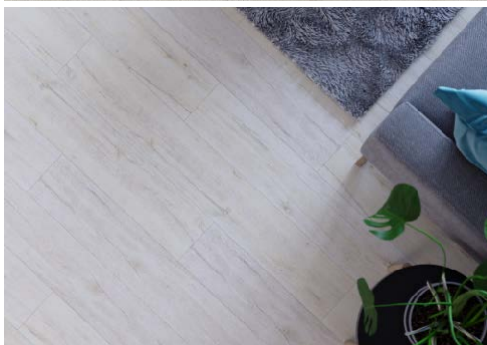

DUB VERMONT





BiCreative
SYSTEM

AFIRMAX

NOVÁ
PODLAHA
BĚHEM
JEDNOHO
ODPOLEDNE

REVOLUCE V RENOVACI

BiCreative
SYSTEM

Minimální příprava podkladu
(eliminuje malé nerovnosti) a
instaluje se mnohem rychleji než
při použití montážního lepidla.



**PŘÍMO NA
KERAMICKÉ
DLAŽDICE**

ŽÁDNÝ NEPOŘÁDEK, ŽÁDNÉ SPECIÁLNÍ NÁSTROJE



1. POLOŽTE PODLOŽKU

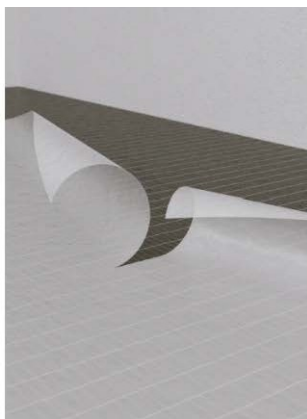

2. ODSTRANĚTE OCHRANU



3. PŘILEPTE PODLAHU

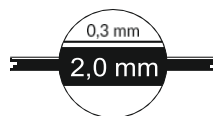
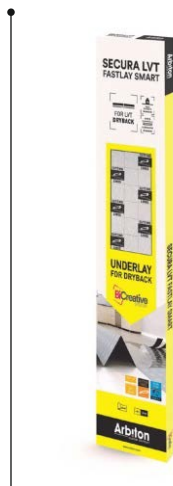

119 mm

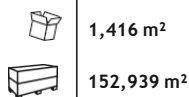

1,416 m²

152,939 m²

595 mm

Podlahy instalované s Fastlay lze použít téměř okamžitě po instalaci. (Doba lepení je 30 minut)

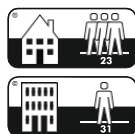

NOVÁ PODLAHA O KTERÉ JSTE VŽDY SNILI

BĚHEM JEDNOHO ODPOLEDNE



POUŽÍJTE PŘEDSTAVIVOST, **B**ICREATIVE! (BUĎTE KREATIVNÍ)

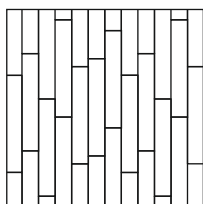

Britský vzor

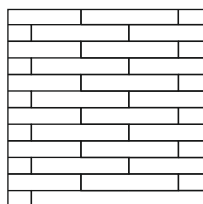

cihla

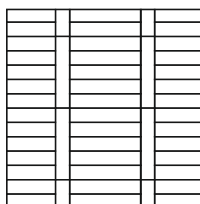

žebřík

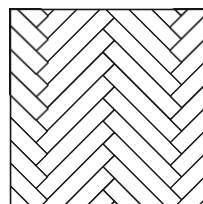

stromkový vzor

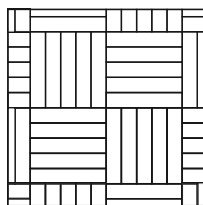

šachovnice

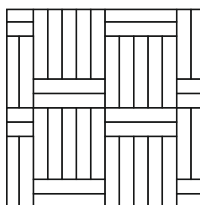

propletení

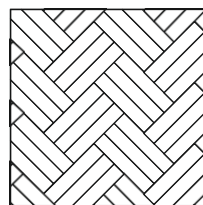

trojitý stromkový vzor

DUB CHENNAI

CIHLA

STROMKOVÝ VZOR



BiCreative

DUB CHENNAI DBC 21142
EAN 5905167814420

DUB SCANDINAVIAN

CIHLA

STROMKOVÝ VZOR

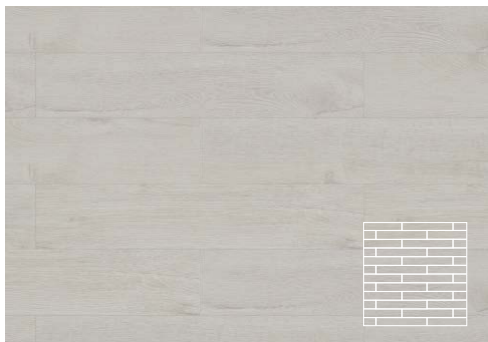

BiCreative
SYSTEM

DUB SCANDINAVIAN DBC 21022
EAN 5905167814383

DUB VERMONT

CIHLA

STROMKOVÝ VZOR



BiCreative
SYSTEM

DUB VERMONT DBC 21072
EAN 5905167814444